

Simulink Model for Battery Management System in Electric Vehicles

Asst. Prof, Ms. A. Sunantha, M. Sonalika, B. Suman Nayak, G. Sai Charan
Department of Electrical & Electronics Engineering
ACE Engineering College Hyderabad, India

Abstract. With the advent of Electric vehicles (EV), high voltage battery packs have gained considerable significance. In an electric vehicle, the battery is the most important resource of power. Improper use of battery packs could be harmful. In a battery management system, control and monitoring are key role in electric vehicle existence. Dedicated electronic circuitry known as a Battery Management System is often used to perform this function. In this paper, simulation is present as a tool for understanding BMS. Designers can use simulation to recognize and correct the errors. For validation of results, the simulation was carried out in MATLAB/SIMULINK.

Keywords: Electric Vehicles, Battery Management System (BMS), MATLAB/SIMULINK.

1. Introduction

Battery management system (BMS) is a managerial technique, which helps in monitor and calculating the diverse parameters of rechargeable batteries. BMS can be classified into both: simple and complex. A simple BMS deals the amount of voltage and restrict the flow of current, when preferred bound is reached. Whereas, a more complex BMS monitor the various parameters of the battery, to efficiently amplify its battery existence and also boost its efficiency. The simulation is agreed that, using MATLAB/SIMULINK to manage and supervise the various aspects of lithium ion batteries.

2. Cell - Configuration

The configuration of cells, while scheming a BMS is very essential. The various cell configurations can be arranged as follows:

1. Series configuration

Series configuration with four cells as shown in Fig.1. Series configuration is preferred for portable equipments that require high voltage rating.



Fig. 1 Series Connection

The conductor size is essential for high voltage batteries and conductor sizes are small. Electronic bikes or e bikes usually come with a voltage rating of 24V, 36 V or 48V. A mild hybrid car in generally operate with a cell rating of 48V and uses a DC-DC convertor for the electrical system. When high voltage batteries are worked in cold temperature conditions or for taking heavy loads currents, necessary safety measures are taken for cell matching, as there is always a chance of a cell falling when a number of cells are connected in series.

2. Parallel Configuration

Parallel configuration with four cells as shown in Fig.2 Parallel configuration is chosen when large current rating is preferred but large cells are not offered or do not blend in the calculated model.

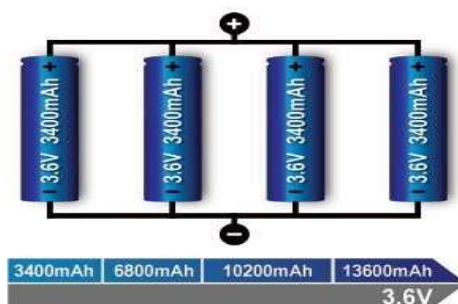

Fig.2 Parallel Connection

If a cell has less resistance and opens up, then it will be less critical to arrange it in parallel than in series. For cells in parallel connection, the total capacity and runtime progressively increases but the voltage remains constant.

Combination of Series and Parallel Configuration

By combining series and parallel configuration, the BMS design gain flexibility and also attains the desired voltage and current ratings with a standard cell size. Combination of series and parallel configuration with cells arrangement as shown in Fig.3. Lithium-ion tends to have better efficiency and performance when the cells are arranged in a arrangement of both series and parallel configuration, but stable monitoring is also essential for keep the various values of the battery within satisfactory limits.



Fig. 3 Series and Parallel Connection

3. Cell Parameters

Cell parameters are the different characteristics of the battery that are observed to confine them within satisfactory limits. The different variables monitored are state of charge, charging and discharging of battery cells and voltage

1. State of Charge (SOC)

Definition of SOC

The SOC is one of the most significant parameter for batteries. In general, the SOC of a battery is defined as the ratio of its current capacity (Q(t)) to the nominal capacity (Qn). The nominal capacity is given by the manufacturer and constitutes the greatest amount of charge that can be stored in the battery. The SOC can be defined as follows:

$$SOC(t)=Q(t)/Q_n$$

State Of Charge of a battery is a estimate the amount of charge existing in the battery with respect to its actual capacity. SOC is evaluated in percentage.

Review of SOC Evaluating Mathematical Model

The different assessment of estimating SOC is available in the literature [4,5]. Among all most important technique is direct measurement scheme and book keeping assessments are widely used.

Table.1. SOC assessment schemes

Categories	Mathematical methods
Direct as- sessment	Open Circuit Voltage Assessment
Book- keeping as- sessment	Coulomb counting method

The specific SOC assessment schemes in view of the approaches as shown in Table1.

Direct Assessment: In direct evaluation techniques, parameters like terminal voltage and impedance of the battery are directly noted. Open Circuit Voltage (OCV) Assessment: In this method, the linear correlation between the SOC of the battery and the OCV (Open Circuit Voltage) of the battery is given as,

$$V_{oc}(t) = a_1 * SOC(t) + a_0$$

Where, SOC (t) refers to the SOC of the battery at the time interval 't'. a₀ refers to the terminal voltage of the battery when SOC is equal to 0%. a₁ refers to the terminal voltage of the battery when SOC is equal to 100%. Unlike lead acid batteries, lithium ion batteries do not have a linear relationship between SOC and OCV.

A typical graph depicting non linear relationship between OCV and SOC for lithium ion batteries is shown in Fig.4.

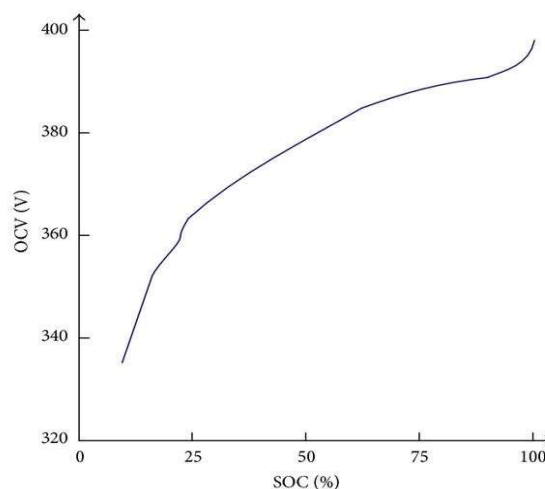

Fig 4.Non linear relationship between OCV and SOC for a lithium ion battery

Coulomb Counting Technique:

This technique helps in measuring the amount of discharging current in a battery. It performs integration of discharging current over time, in order to estimate the SOC. The equation used in this method is given by,

$$SOC(t) = SOC(t-1) + [I(t)/Q_n * \Delta t]$$

Some of the parameters that affect the coulomb counting assessment are: temperature, battery history, discharge current and life cycle.

2. Charging and Discharging of the Battery Cells:

The charging of the battery is done in two modes, one is constant current mode and another is constant voltage mode. The maximum allowable current is specified in the name plate, in this study we taken as 22 A for both constant current and constant voltage measurements. These both measurements are done at 80% of SOC level. A different control algorithm is required to charge 80% of the battery to 100%

During the discharge mode, our reference is 48V and we will use PI Controller in this mode. When the battery is in discharging mode, the SOC decreases but the battery current stays positive and the load voltage is about 48V. The system is separately working in two stages, but we incorporate a switch, so as to combine both the stages. The switch depends on the voltage source for determining its operation. When the voltage source is enabled, battery is charging and the load is supplied from the source. When the voltage source is disabled, battery is discharging and the load is supplied from the battery.

3. Voltage:

In order to show the voltage based control result up to 80%, we need a PI Controller for determining reference battery current. The reference current is specified in battery (for example 22 A), because the battery voltage is less than 25.98V. Using the PI

voltage controller, it is reduced and the battery starts charging at 25.98V and 16A. While the battery is charging, the voltage increases and the current decreases.

4. Simulation of Battery Management System (BMS)

The components that were used for study and to design the following simulation model were:

1. Battery
2. DC voltage source
3. Bidirectional DC-DC converter
4. Common load

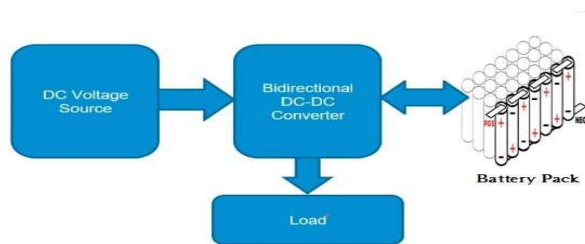

Fig.5 Block Diagram of BMS in EV.

Fig.5 shows the arrangement of components for this study. For the purpose of modeling of the battery, the battery packs DC-DC converter and PI controller in different driving modes, the MATLAB software is used. In the MATLAB graphical editor simulink a generic model of Lithium-Ion battery according to Shepherd's model is developed and verified. It is modeled as a controlled voltage source dependent on the actual state of the battery charge (SOC). Idea of this design is the use of a simple procedure to obtain the input parameters for the battery model from the battery manufacturer's catalogue data. Within the model, depending on the operating modes, there are different functions for dependency of battery voltage. The simulink block for constant current and constant voltage modes of operation. Proposed BMS model including SOC parameter monitoring. For this study, when SOC enabled at settings (numerical value entered in simulink block), depends on state of the battery charge or discharge may occur.

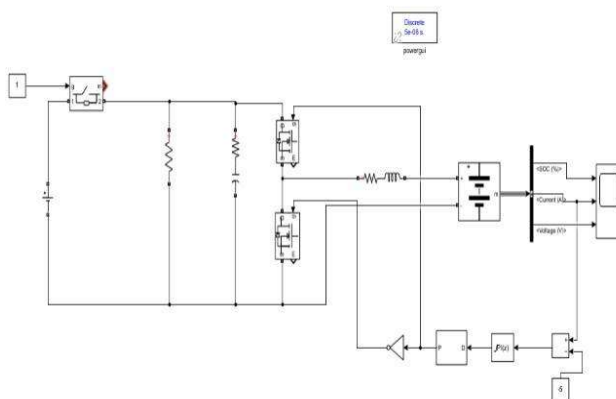

Fig.6 Simulink block for constant current mode of operation.

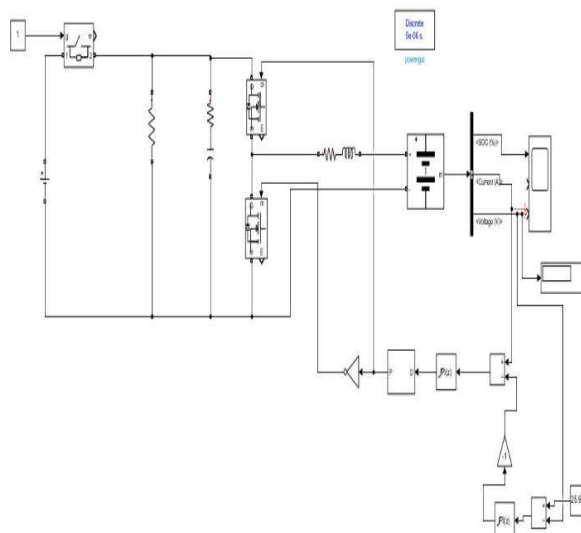

Fig.7 Simulink block for constant voltage mode of operation.

5. Results

The simulation output of battery charging and discharging at constant current mode when state of charge (SOC) is enabled by 50% in this study, by all subsystem blocks have generated signals as shown in BMS simulation model output. In addition, the outcome shown in reflects the battery SOC, current & voltage, during charging and discharging state of the battery at constant voltage mode. All the data shows the simulation is running in a successful state. When the voltage source is disabled, the battery will supply the load. When the voltage source is enabled, the battery will charge and the load will be supplied from the voltage source. The charging mode output of the proposed BMS model gives proper and desired output.

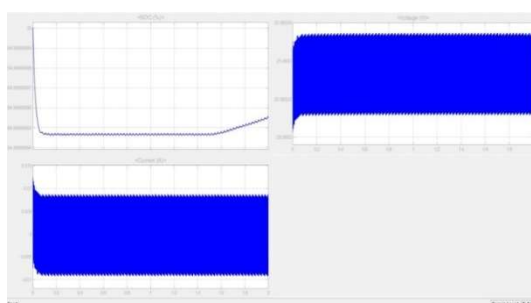

Fig.8 Simulink output-charging state of the battery at constant voltage mode.

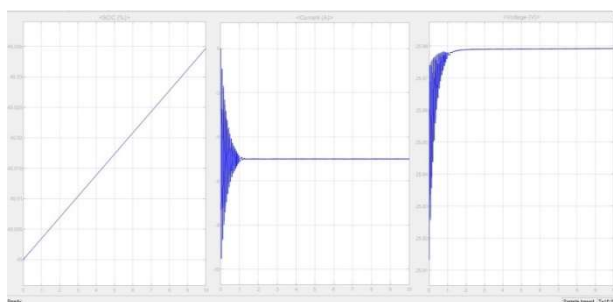

Fig.9 Simulink output-charging state of the battery at constant current mode.

6. Conclusion

Using the simulation model of constant current mode of operation and constant voltage mode of operation, we were able to monitor the different parameters such as SOC, charging, discharging and voltage. The various advantages of designing the simulation model prior to the hardware are time saving, cost effective and identifying errors. The various applications of BMS are used for electric vehicles (EV), Electronic Devices (ED), stationary battery energy storage and used in aviation, drones, power tools.

ACKNOWLEDGMENT

Authors would like to express our sincere thanks to Prof. Y.V. Gopala Krishna Murthy, General Secretary, Dr. B. L. Raju, Principal, and Dr. S. Mani Kuchibhatla, Head of the Department and Associate Professor, ACE Engineering College, Hyderabad for their encouragement and support.

References

1. Park, K. H.; Hong, K.Y.; Kang, J. All-graphene-battery: bridging the gap between supercapacitors and Lithium ion batteries, *Scientific Reports* 4, Num. 5278 (2014), DOI: 10.1038/srep05278.
2. Jianwu, W.; Yan, Y.; Chunhua, C. A Review on Lithium-Ion Batteries Safety Issues: Existing Problems and Possible Solutions, *Materials Express*, 2, 3(2012), pp. 197-212.
3. Taylor, W.; Krithivasan, G.; Nelson, J. System safety and ISO 26262 compliance for automotive Lithium-Ion batteries, 2012 IEEE Symposium on Product Compliance Engineering Proceedings, (2012), pp. 1-6.
4. Imai, T.; Yamaguchi, H. Dynamic battery charging voltage optimization for the longer battery runtime and lifespan, 2013 IEEE 2 nd Global Conference on Consumer Electronics(GCCE), pp.219-223, DOI:10.1109/GCCE.2013.6664804.



5. Tremblay, O.; Dessaint, L.-A. Experimental Validation of a Battery Dynamic Model for EV Applications, *World Electric Vehicle Journal*, (2009), pp. 289-298.
6. Tremblay, O.; Dessaint, L.-A.; Dekkiche A. I. A Generic Battery Model for the Dynamic Simulation of Hybrid Electric Vehicles, *IEEE Vehicle Power and Propulsion Conference*, (2007), pp 284-289.
7. Methods for state of charge determination and their applications‘ byMeng Di Yin, JiaeYoun, Jeonghun Cho .(2018).
8. K. Saadaoui, K. S. Rhazi and A. Aboudou, “Hybridization and energy storage high efficiency and low Cost,” 2020 6 th IEEE Congress on Information Science and Technology (CiSt), 2020, pp. 33-41, DOI: 10.1109/CiSt49399.2021.9357198 .